



PANCHE

Struttura: portante in HPL con piano in legno multistrati. Imbottitura in poliuretano espanso a quote differenziate accoppiata a fibra termolegata traspirante. Cornice perimetrale in metallo satinato, verniciato color Malto.

Sfoderabilità: il rivestimento è completamente sfoderabile sia nella versione in tessuto che in pelle.

Gambe: lame in alluminio satinato, spessore mm 15, verniciate color Malto. Piedini regolabili in metallo verniciato color Malto. Scivolante protettivo in ABS.

SIDE TABLES / CONSOLE

Finiture piano:

- MDF, spessore mm 16, impiallacciato wengé spazzolato, laccato a poro aperto color Moka;
- marmo Zebrino, spessore mm 16, sagomato;
- vetro temperato retroverniciato nero, spessore mm 8.

Cornice perimetrale in metallo satinato, verniciato color Malto. Tutti i piani sono supportati da un pannello strutturale di alluminio stratificato, verniciato Nero opaco. Side table da cm 160 e consolle da cm 160 hanno il piano in marmo diviso in due parti.

Gambe: lame in alluminio satinato, spessore mm 15, verniciate color Malto. Piedini regolabili in metallo verniciato color Malto. Scivolante protettivo in ABS.

BENCHES

Structure: structure made of HPL with a layer of plywood. Padding in variable-density polyurethane foam bonded to breathable heat-bonded fiber. Satin finish metal perimeter frame, varnished Malt colour.

Covers: fully removable both in fabric and leather.

Legs: 15 mm thick satin finish aluminium blades, varnished Malt colour. Adjustable metal feet painted Malt colour. Protective ABS glides.

SIDE TABLES / CONSOLE TABLE

Top finishes:

- MDF, 16 mm thick, with brushed wenge veneer, open pore Moka colour lacquer finish;
- Zebrino marble, 16 mm thick, contoured;
- tempered Black backpainted glass, 8 mm thick.

Satin finish metal perimeter frame, varnished Malt colour. All tops are supported by a structural panel in laminated aluminium, matt Black varnished finish. Marble tops of the 160 cm side table and console table are divided into two pieces.

Legs: 15 mm thick satin finish aluminium blades, varnished Malt colour. Adjustable metal feet varnished Malt colour. Protective ABS glides.

BANKEN

Struktur: Sitzfläche aus HPL mit Oberfläche aus Schichtholz. Polsterung aus unterschiedlich dick geschäumtem Polyurethan und selbstbindender Faser. Umrahmung aus satiniertem, malzfarbig lackiertem Metall.

Abziehbarkeit: der Bezug ist komplett abziehbar sowohl in Stoff als auch in Leder.

Beine: Satiniert malzfarbig lackierte Aluminiumleisten, Stärke 15 mm. Verstellbare, malzfarbig lackierte Füßchen. Gleitschutz aus ABS.

SIDE TABLES / KONSOLE

Tischplatte:

- MDF, Stärke 16 mm, furniert mit offenporig mokkafarbig lackiertem gebürstetem Wenge;
- Zebrino Marmor, Stärke 16 mm, formgeschnitten;
- rückseitig schwarz lackiertes gehärtetes Glas, Stärke 8 mm.

Umrandung aus satiniertem, in der Farbe Malz lackiertem Metall. Alle Platten liegen auf einer darunterliegenden Stützplatte aus laminiertem, mattschwarz lackiertem Aluminium auf. Die Side table und der Konsole mit 160 cm Länge haben eine aus zwei Teilen bestehende Platte.

Beine: Eine flache, satinierte Aluminiumstrebe, Stärke 15 mm, in der Farbe Malz lackiert. Regulierbare Metallfüßchen, in der Farbe Malz lackiert. Gleitschutz aus ABS.

BANCS

Structure : soutien en HPL avec plateau en contreplaqué. Rembourrage en polyuréthane expansé à hauteurs différentes, doublé de fibre thermoliée respirante. Cadre périmétrique en métal satiné, laqué couleur Malt.

Déhoussage : revêtement en tissu et en cuir entièrement déhoussable.

Pieds : lames en aluminium satiné, épaisseur 15 mm, laqué couleur Malt. Petits pieds réglables en métal peint couleur Malt. Patins glisseurs en ABS.

SIDE TABLES / CONSOLE

Finitions plateau :

- MDF épaisseur 16 mm, plaqué wengé brossé, laqué à pores ouverts couleur Moka ;
- marbre Zebrino, épaisseur 16 mm, façonné ;
- verre trempé rétro-laqué Noir, épaisseur 8 mm.

Cadre périmétrique en métal satiné, laqué couleur Malt. Tous les plateaux sont doublés d'un panneau structural en aluminium stratifié, laqué Noir mat. Le plateau en marbre de side table et de console de 160 cm est divisé en deux parties.

Pieds : lames en aluminium satiné, épaisseur 15 mm, laqué couleur Malt. Petits pieds réglables en métal laqué couleur Malt. Patins glisseurs en ABS.

FINITURE PIANO TOP FINISHES

MARMO MARBLE

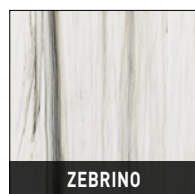

WENGÉ WENGE

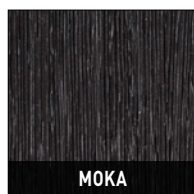

VETRO RETROVERNICIATO BACKPAINTED GLASS



FINITURA GAMBE LEGS FINISH

ALLUMINIO SATINATO SATIN ALUMINIUM



PANCHE | BENCHES

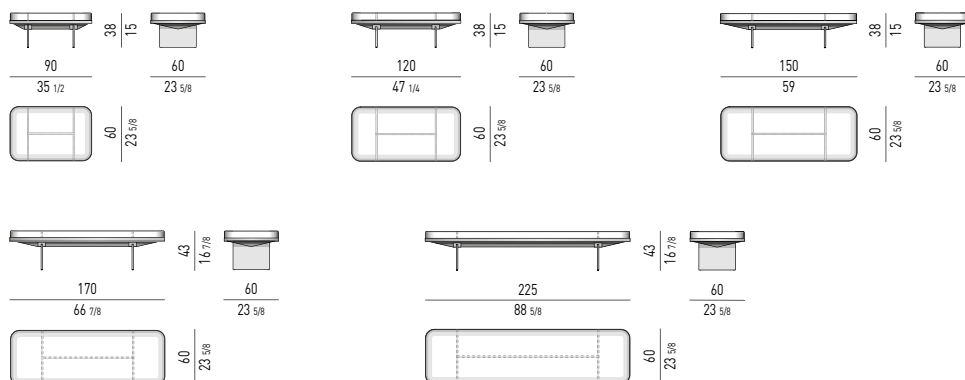

CONSOLLE | CONSOLE TABLE

PIANO MARMO ZEBRINO | ZEBRINO MARBLE TOP

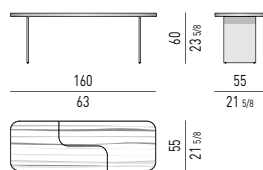

SIDE TABLES

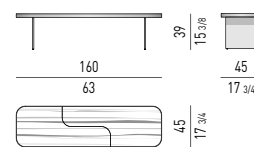
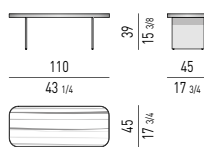
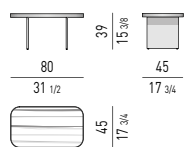

CONSOLLE | CONSOLE TABLE

PIANO WENGÉ | WENGE TOP

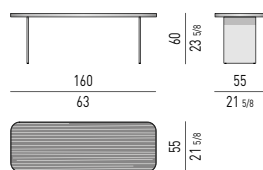

SIDE TABLES

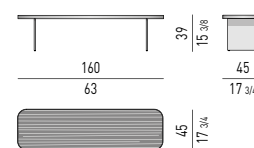
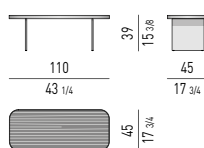
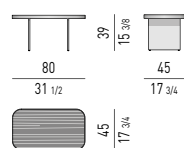

CONSOLLE | CONSOLE TABLE

PIANO VETRO | GLASS TOP

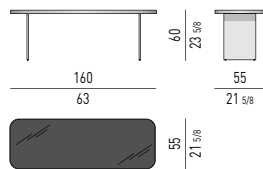

SIDE TABLES

